

# Carey Automatic Door, LLC

## 1 - PNEUMATIC OPERATOR FOR SINGLE SWINGING DOOR

“IN” for Doors Swinging under Operator

“OUT” for Doors Swinging away from Operator

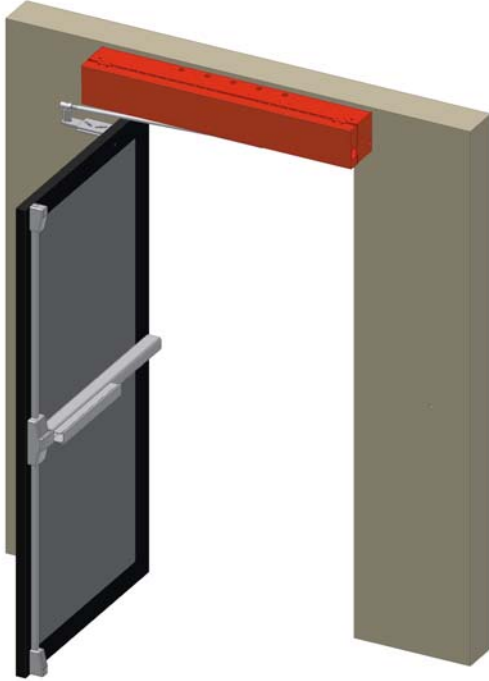

Packages 1, 2 & 3



Packages 4, 5 & 6

**FACTORS TO CONSIDER BEFORE ORDERING:**

- HAND:** Specify Right Hand for clockwise swinging doors, Left Hand for counterclockwise swinging doors.
- REVEAL:** Distance from back of operator case to inside surface of door in closed position. Varies with door thickness and hanging. See detail sheet MDS-255 on Page CP-19 for additional information.
- SIDE CLEARANCE:** Distance required between jamb and side wall for door bracket.
- OPENING:** Determines size of operator required.
- SAFETY SWITCH:** Safety Switch 4080987 required when safety device is used.

All operators shipped as single acting. Closing Valve Kit (307381, ALL AIR 940100) is available as extra for double acting. Recommended where windy conditions exist.

Emergency Release available for “IN” applications. Refer to Package No. 2.

When operator is to be concealed either above the ceiling or below the floor, consult Pages CP-6 & CP-6A for details.

**CONSIDER WHETHER YOU NEED ANY OR ALL OF THE FOLLOWING:**

Closing Valve Kit 307381, 940100 for Double Acting Operation; Safety Switch 408987; Controls; and Door Pivots or Hinges.

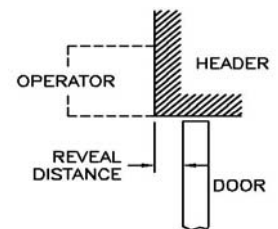

**Carey Automatic Door, LLC**  
**1 - PNEUMATIC OPERATOR FOR SINGLE SWINGING DOOR**

**FOR SINGLE "IN" SWINGING DOOR**  
**For ALL AIR, See Page CP-3B**

PKG NO.	PART NO.*	DESCRIPTION	SIZE OF OPENING	MAX. REVEAL SEE MDS-255	SIDE CLEARANCE
1	307695	14" 01 IN	30" to 48"	4"	8 1/8"
2	307696	14" 01 IN w/Emergency Release	30" to 48"	4"	8 1/8"
3	307697	24" 01 IN	49" to 72"	9 1/2"	15 1/4"

PACKAGE NO. 1	PACKAGE NO. 2	PACKAGE NO. 3	ITEM DESCRIPTION
1 - 103155 (6)	1 - 103155 (6)	--	OPERATOR-OS-14" R.H. (L.H)
--	--	1 - 103159 (60)	OPERATOR-OS-24" R.H. (L.H)
1 - 403257	1- 403257	1 - 403257	SLIDE BAR - Universal
1- 502494	--	--	DOOR BRACKET - SDB-114 "IN"
--	1- 311806	--	DOOR BRACKET O17V-14" Emer Rel.
--	--	1 - 304034	DOOR BRACKET - MHO-24 "IN"
1- 409318	1- 409318	1 - 409318	DOOR ROD
1- 515430	1- 515430	1 - 515430	PLUG IN RELAY

**FOR SINGLE "OUT" SWINGING DOOR**  
**For ALL AIR, See Page CP-3B**

PKG NO.	PART NO.*	DESCRIPTION	SIZE OF OPENING	MAX. REVEAL SEE MDS-255	SIDE CLEARANCE
4	307698	14" 01 OUT	30" to 48"	4"	8 1/8"
5	307699	14" 01 OUT Wide Throw	30" to 48"	4"	8 1/8"
6	307700	24" 01 OUT	49" to 72"	8 1/2"	11 1/8"

PACKAGE NO. 4	PACKAGE NO. 5	PACKAGE NO. 6	ITEM DESCRIPTION
1 - 103155 (6)	1 - 103155 (6)	--	OPERATOR-OS-14" R.H. (L.H)
--	--	1 - 103159 (60)	OPERATOR-OS-24" R.H. (L.H)
1 - 403257	1- 403257	1 - 403257	SLIDE BAR - Universal
1- 502495	--	--	DOOR BRACKET - SDB-114 "OUT
--	1- 502891	--	DOOR BRKT-14" "OUT" Wide Throw
--	--	1 - 304040	DOOR BRACKET - MHO-24 "OUT"
1- 409318	1- 409318	1 - 409318	DOOR ROD
1- 515430	1- 515430	1 - 515430	PLUG IN RELAY

\*NOTE: For LH Packages, change 2nd digit of part number to = 8.

**Carey Automatic Door, LLC**  
**1 - PNEUMATIC OPERATOR FOR SINGLE SWINGING DOOR**

**ALL AIR FOR SINGLE "IN" SWINGING DOOR**

PKG NO.	PART NO.*	DESCRIPTION	SIZE OF OPENING	MAX. REVEAL SEE MDS-255	SIDE CLEARANCE
1AA	347695	14" 01 IN All Air	30" to 48"	4"	8 1/8"
2AA	347696	14" 01 IN w/Emer. Release All Air	30" to 48"	4"	8 1/8"
3AA	347697	24" 01 IN All Air	49" to 72"	9 1/2"	15 1/4"

PACKAGE NO. 1AA	PACKAGE NO. 2AA	PACKAGE NO. 3AA	ITEM DESCRIPTION
1 - 103305 (6)	1 - 103305 (6)	--	OSX-14" R.H. (LH) All Air Operator
--	--	1 - 103307 (8)	OSX-24" R.H. (LH) All Air Operator
1 - 920100	1 - 920100	1 - 920100	ALL AIR VALVE PACKAGE
1 - 403257	1 - 403257	1 - 403257	SLIDE BAR - Universal
1 - 502494	--	--	DOOR BRACKET - SDB-114 "IN"
--	--	1 - 304038	DOOR BRACKET - MHO-24 "IN"
--	1 - 311806	--	EMERGENCY REL. BRACKET
1 - 409318	1 - 409318	1 - 409318	DOOR ROD
2 - 402839 OR	2 - 402839 OR	2 - 402839 OR	PULL CORD MA-10 OR
2 - 409693	2 - 409693	2 - 409693	PALM BUTTON

**ALL AIR FOR SINGLE "OUT" SWINGING DOOR**

PKG NO.	PART NO.*	DESCRIPTION	SIZE OF OPENING	MAX. REVEAL SEE MDS-255	SIDE CLEARANCE
4AA	347698	14" 01 OUT All Air	30" to 48"	4"	8 1/8"
5AA	347699	14" 01 OUT w/Emer. Release All Air	30" to 48"	4"	8 1/8"
6AA	347700	24" 01 OUT All Air	49" to 72"	8 1/2"	11 1/8"

PACKAGE NO. 4AA	PACKAGE NO. 5AA	PACKAGE NO. 6AA	ITEM DESCRIPTION
1 - 103305 (6)	1 - 103305 (6)	--	OSX-14" R.H. (LH) All Air Operator
--	--	1 - 103307 (8)	OSX-24" R.H. (LH) All Air Operator
1 - 920100	1 - 920100	1 - 920100	ALL AIR VALVE PACKAGE
1 - 403257	1 - 403257	1 - 403257	SLIDE BAR - Universal
1 - 502495	--	--	DOOR BRACKET - SDB-114 "OUT"
--	1 - 502891	--	DOOR BRKT-14" OUT Wide Throw
--	--	1 - 304040	DOOR BRACKET-MHO-24 "OUT"
1 - 409318	1 - 409318	1 - 409318	DOOR ROD
2 - 402839 OR	2 - 402839 OR	2 - 402839 OR	PULL CORD MA-10 OR
2 - 409693	2 - 409693	2 - 409693	PALM BUTTON

\*NOTE: For LH Packages, change 2nd digit of part number to = 5.

See Page CP-13 for additional ALL AIR and Explosion Proof information.

<h2 style="margin: 0;">Carey Automatic Door, LLC</h2> <h3 style="margin: 0;">OSX ALL AIR (EXPLOSION PROOF) OPERATOR PACKAGES</h3>
---

### 100% ALL AIR & EXPLOSION PROOF PACKAGES

**100% ALL AIR door systems** are pneumatically operated with no electronics. **Explosion Proof door systems** are pneumatically operated with no electronics as well as all moving components are manufactured from non-sparking materials.

**100% ALL AIR & EXPLOSION PROOF OPERATORS:**

**Air Opening and Air Closing (no electricity involved)** - pneumatically controlled from central air supply or separate compressor. Opening and closing action will be individually controlled by separate built-in pressure regulators and opening and closing valves, which are all adjustable for pressure and volume for required speed and power. All regulators and valves can be self-contained within a control box at the door location. The operator will be capable of operating doors against wind velocities (and equivalent stack pressures) up to 40 miles per hour. Built-in two-stage checking cylinders for both opening and closing limits. The operator will instantaneously recycle the door to the full open position from any point in closing cycle. The operator will be activated by two pneumatic push plate or pull cord assemblies. The entire system is driven by pneumatic cylinders and valves without the use of electrical or electronic components.

**All Operators available as ALL AIR. The following are excluded as Explosion Proof Packages: 17, 18, 19, 20, 21, 22, 23, 26, 27, 30, 31, 32, 37, 38, 39, 40, 55, 56 & 57.**

**FACTORS TO CONSIDER BEFORE ORDERING:**

- HAND:** Swinging Doors - Specify Right Hand for clockwise, Left Hand for counterclockwise.  
Sliding Doors - Specify Right Hand if door slides to the left to open, Left Hand if door slides to right.
- REVEAL:** Distance from back of operator case to inside surface of door in closed position.  
Varies with door thickness and hanging. (See Detail Sheet MDS-255 on Page CP-19)
- SIDE CLEARANCE:** Distance **required** between jamb and side wall for door bracket.
- OPENING:** Determines size of operator required.

To order **ALL AIR (EXPLOSION PROOF)** equipment select the application required as shown on Pages CP-2 through CP-12A. Order by Part Number. Fire door packages include closing lever with weights.

The ALL AIR (EXPLOSION PROOF) Package Equipment List will differ from the appropriate Standard Package Equipment List as follows:

<u>PART NO.</u>	<u>DESCRIPTION</u>	
103305	OSX - 14" R.H. All Air Operator	Substituted for Regular Operator
103306	OSX - 14" L.H. All Air Operator	Substituted for Regular Operator
103307	OSX - 24" R.H. All Air Operator	Substituted for Regular Operator
103308	OSX - 24" L.H. All Air Operator	Substituted for Regular Operator
920100	ALL AIR Valve Package	1 included in Every Package except Fire Door
402839	Pull Cord - MA-10	2 included in Every Package <b>OR</b>
409693	Wall Mounted Palm Button Switches	2 included in Every Package
960130	All Air Time Delay (0-30 seconds)	1 included in Every Package
960175	All Air Time Delay (0-60 seconds)	Available on special order as an optional extra
311769	Valve Control Panel	Available on special order as an optional extra

**AVAILABLE ACTIVATION OPTIONS:**

- Push to Open, Push to Close
- Push to Open, Hold Open with Time Delay (standard: 30 sec., optional: 60 sec.), Air Power Close

**Customized Systems Available for Specialized Applications.**

*Carey Automatic Door, LLC, its employees and associates are not electrical engineers or building code experts. You should consult the proper experts before purchasing a system in a hazardous area.*

**Carey Automatic Door, LLC**  
**OSX ALL AIR (EXPLOSION PROOF) OPERATOR PACKAGES**

**“IN” SWING OPERATORS**  
**Doors Swing Under the Operator**

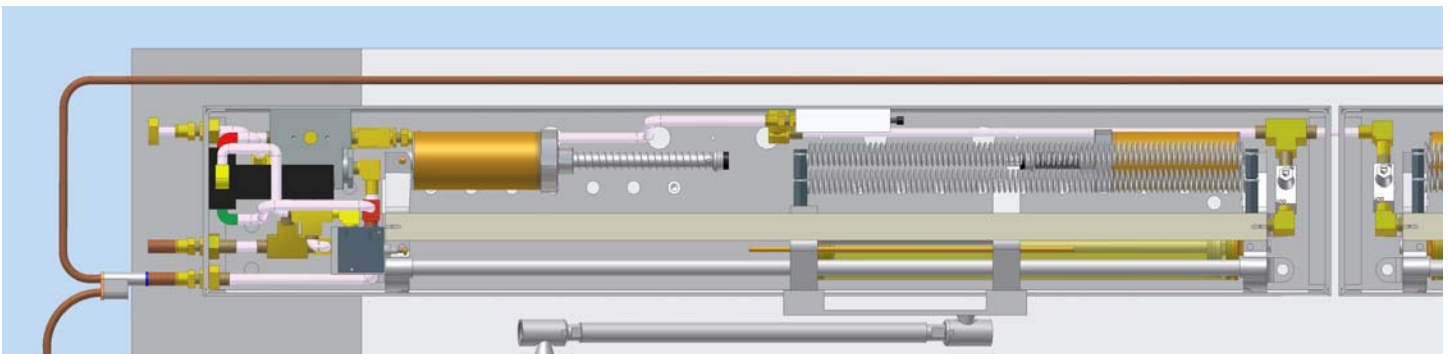
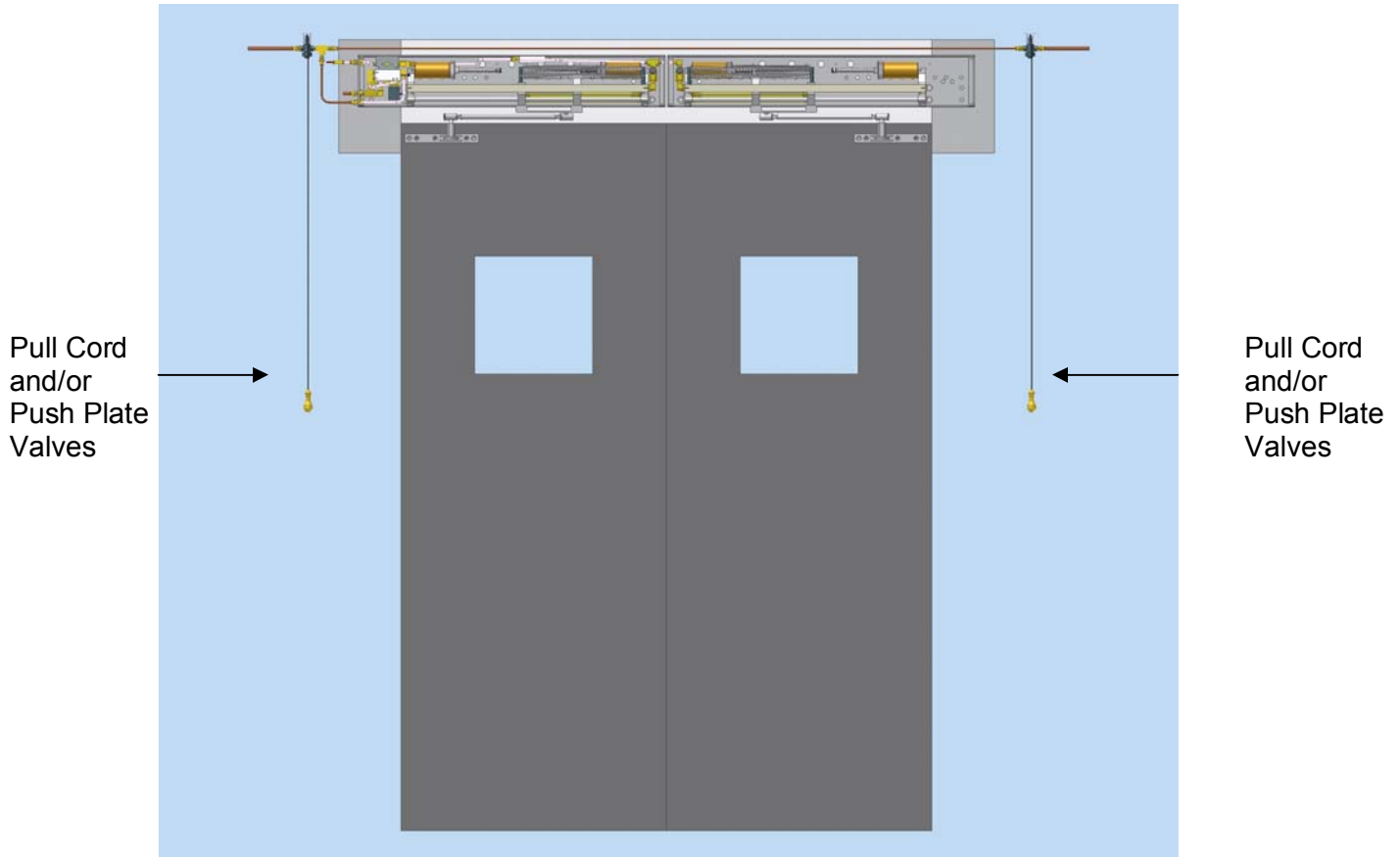

**All Regulators & Valves are Self-Contained with Operator Case!**

# Carey Automatic Door, LLC

## OSX ALL AIR (EXPLOSION PROOF) OPERATOR PACKAGES

**AS MFG. PRIOR TO 1990**

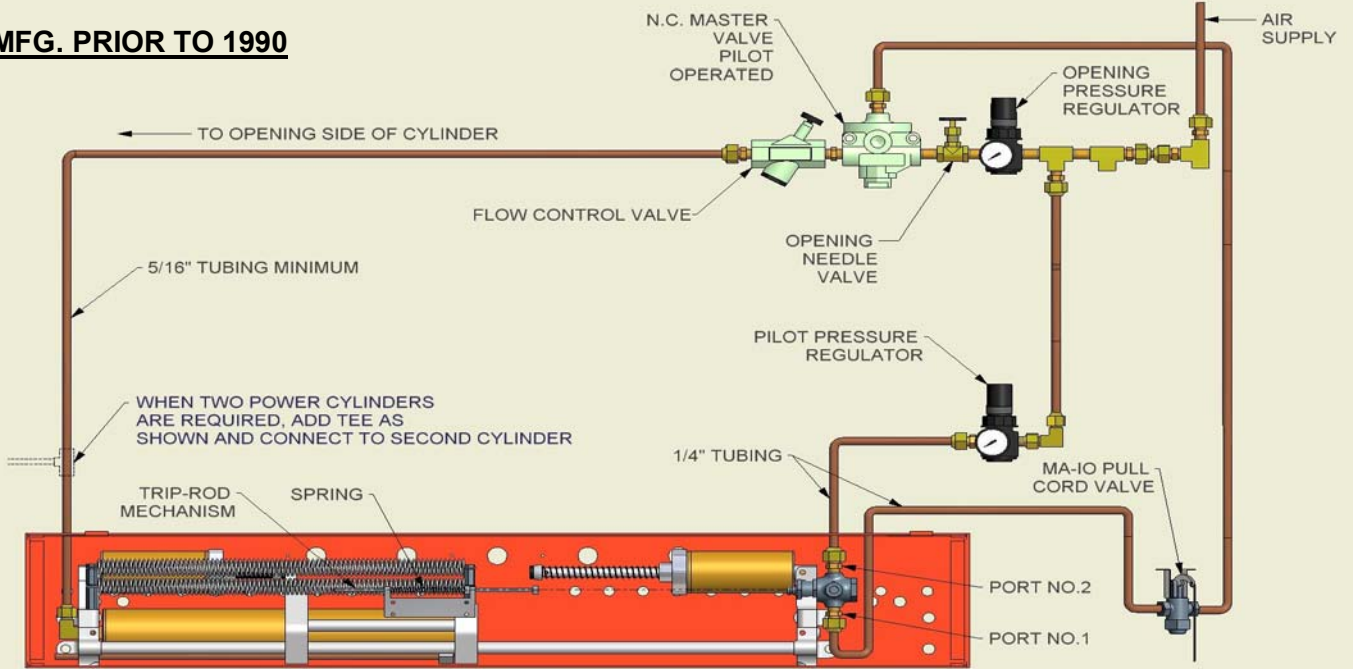

**ALL PNEUMATIC CONTROL WITH SINGLE ACTING AIR AND COUNTER-WEIGHT CLOSING**

**AS MFG. PRIOR TO 1990**

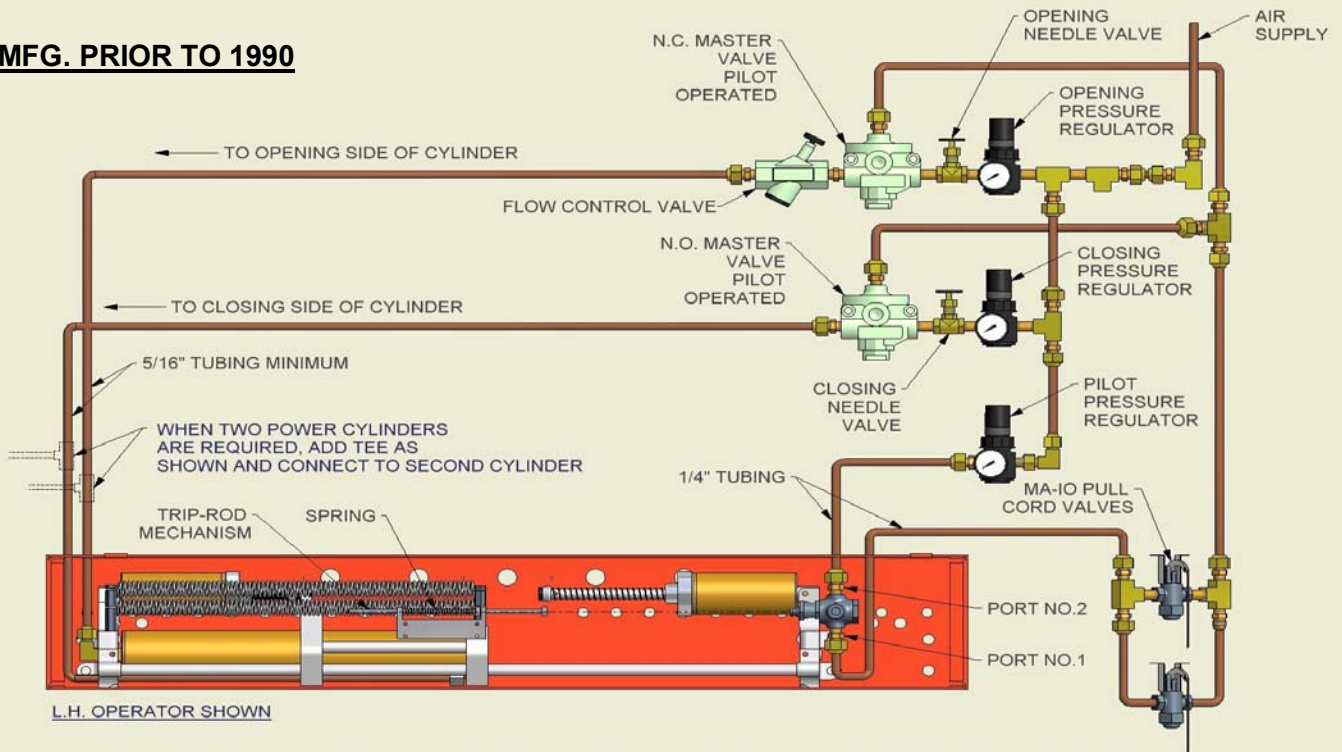

**ALL PNEUMATIC CONTROL WITH DOUBLE ACTING AIR**

# Carey Automatic Door, LLC

## OSX ALL AIR (EXPLOSION PROOF) OPERATOR PACKAGES

### CONTROL BOX ASSEMBLY DOUBLE ACTING

**PART NO.: 511670**

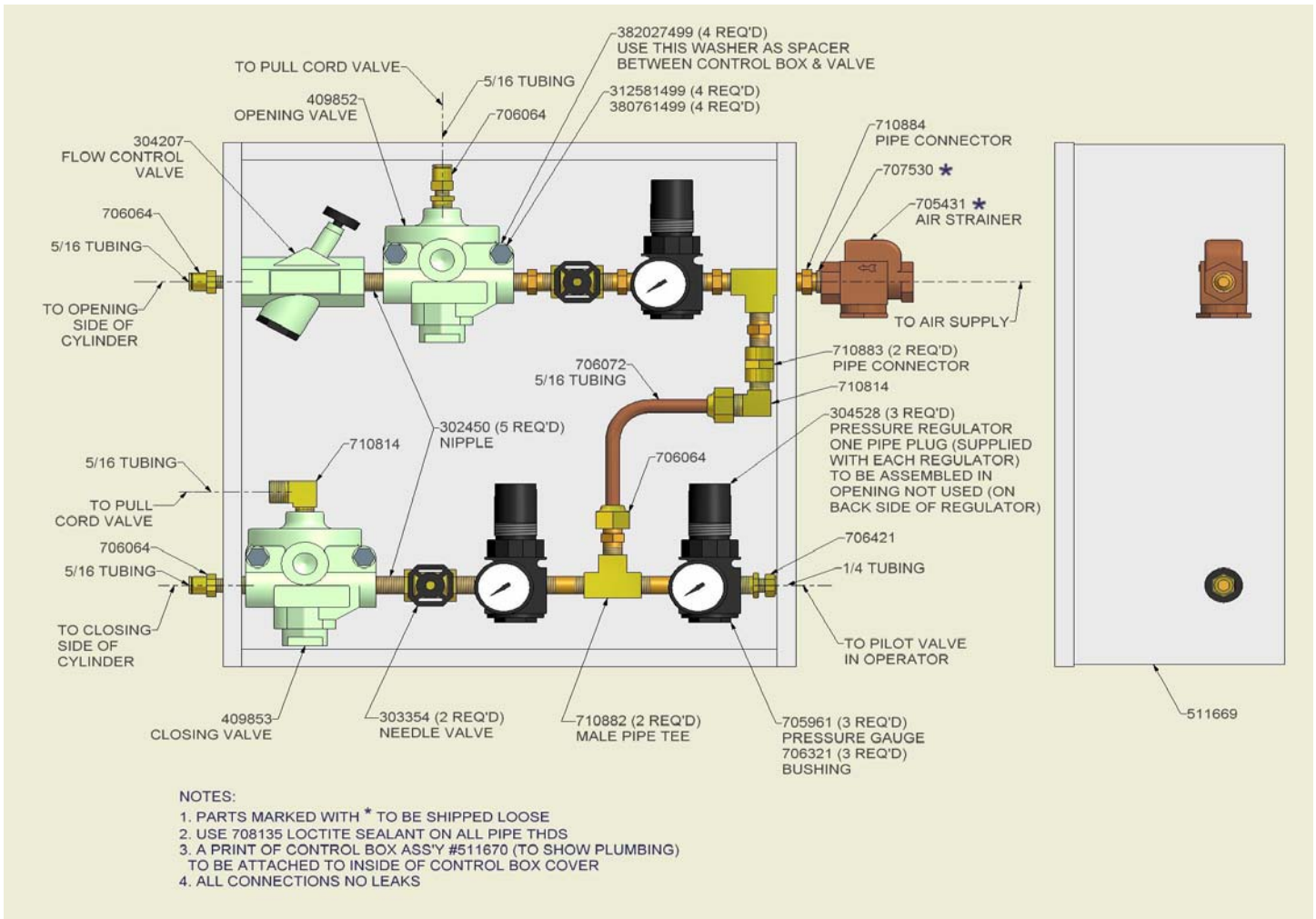

# Carey Automatic Door, LLC

## SPECIFICATIONS: OS PNEUMATIC OPERATORS & CONTROLS

### I. GENERAL

Furnish pneumatic operators (visible or concealed), controls, and accessories, including necessary connecting hardware and air supply, as indicated on architectural plans and in accordance with manufacturer's working drawings, wiring diagrams and instructions. Equipment shall be as manufactured or supplied by Carey Automatic Door, LLC of Southbury, Connecticut.

### II. SCOPE OF WORK

**A. The General Contractor** shall coordinate his work with the work of all trades, including Masonry, Plumbing, Electrical, Automatic Doors sections of the specifications and as covered in Architectural and Manufacturer's details. For overhead installation of the operator, header construction adequate to support the operator shall be provided.

**A-1. Under Automatic Doors Section:** The Automatic Doors contractor shall furnish and install the Pneumatic Operator, door arms and connecting rods, carpets or other controls, molding and other accessories. Work to be in strict accordance with manufacturer's recommendations.

**A-2. Under Masonry Section:** When concealed under-floor application is required, the Masonry contractor shall grout and plumb special floor pivot supplied by Carey Automatic Door in accordance with manufacturer's instructions, and it shall be plumb and true and rigidly mounted to receive operator.

Where molding is required for recessed carpet installations, the Masonry contractor shall provide recesses in floor for carpet frames, and shall set and level carpet frames in accordance with manufacturer's drawings and instructions. Necessary support for operators will be provided in accordance with suppliers detailed drawings.

**A-3. Under Electrical Section:** The Electrical contractor shall provide 115 v., 60 cycle, 1 phase supply to the manufacturer's 115/24 v. transformer. Operator, carpets and manual controls shall be wired to 24 v. circuit. Photoelectric controls shall be wired to 115 v. circuit. Compressor motor shall be wired to nameplate voltage and phase supply.

**A-4. Under Plumbing Section:** The Plumbing contractor shall connect air compressor or central air supply to Pneumatic Operator with brass pipe, copper tubing or equivalent with brass fittings, in accordance with lengths and sizes shown on manufacturer's details and instructions. Minimum pressure in air line before operator pressure regulator shall be at least 20 p.s.i. more than required by operator. The Plumbing contractor shall check with Carey representative for air requirements, since this varies with the operator application (60 p.s.i. will be maximum operator requirements). Furnish and install drain traps where necessary for all low points or pockets in the air line.

### III. FUNCTIONAL

**A. Operators - Air Power Opening and Spring Closing (Single Acting)** - These shall be pneumatically powered from central air supply or separate compressor. Opening action shall be controlled by built-in pressure regulator set and shall be adjustable for pressure and volume for required speed and power at door location. Closing speed shall be controlled by power springs and valve exhaust adjustment. Built-in adjustable two-stage checking cylinders for both opening and closing limits. Operators to contain plug-in type electrical control relays. Operators to instantaneously recycle to full open position from any point in closing cycle.

**B. Operators - Air Power Opening and Air Power Closing (Double Acting)** - These shall be pneumatically powered from central air supply or separate compressor. Opening and closing action shall be individually controlled by separate built-in pressure regulator sets and shall be adjustable for pressure and volume for required speed and power at door location. Operators shall be capable of operating doors against wind velocities (and equivalent stack pressures) up to 40 miles per hour. Built-in adjustable two-stage checking cylinders for both opening and closing limits. Operators to contain plug-in type electrical control relays.

(Continued)

<b>Carey Automatic Door, LLC</b> <b>SPECIFICATIONS: OS PNEUMATIC OPERATORS &amp; CONTROLS</b>
--

**III. FUNCTIONAL**

**C. Actuating Control** - Shall be either or a combination of the following, selected to suit the existing traffic conditions and conform to the operating limits of the control. Optional 3-30 second plug-in time delay relay shall be provided when required.

**Carpet** shall be HD or SC types of waterproof and wear resistant vinyl construction, not more than 1/2" in thickness. Carpet sizes and positioning shall be as indicated on plans. Carpet shall be wired for low voltage (24 v.) circuit by means of a transformer in the control box. Built-in safety features shall prevent opening of door when approached from wrong direction while door is in closed position, and also maintain door in open position when minimum pressure of 10-15 lbs. is applied to either Opening or Safety Carpet. Carpet control shall be limited in application to openings having only pedestrian traffic or light weight rubber tired wheeled traffic. Install in accordance with manufacturer's details and instructions.

**Photoelectric Controls, Models HR-1 (Horizontal) and VR-1 (Vertical)** - Beams shall recognize a minimum interruption of 0.1 seconds and generate a signal and shall operate up to a distance of 40 feet at this sensitivity. Not to be affected by voltage variations between 90-137 volts, 60-cycle, A.C.

**Manual Controls** shall be either or a combination of the following:

C-7	Push Button Switch
C-8	Push Plate Switch
CU-8-E	Explosion-proof Push Plate Switch
C-14	Pull Cord Switch
C-11-A	Floor Button Switch
C-14-A	Explosion-proof Pull Cord Control

**D. Emergency Release Bracket** - shall be furnished where required to quickly disengage the operator and permit an in-swinging door to swing outward. Manual return of door to closed position will re-engage the operator automatically.

**E. Miscellaneous** - Where required, use the following accessories:

- Rails - Models P-60 or P-50
- Stanguard Protectors - Model G-101
- Carpet Molding - To conform to carpet.

**F. Air Supply** - Shall be either central air supply or separate compressor. Must be capable of delivering the necessary C.F.M. free air as required by type and number of pneumatic operators. Consult Carey representative for capacity recommendations.

**IV. BILL OF MATERIALS AND DETAILS**

Consult Carey representative for information.

<b>Carey Automatic Door, LLC</b> <b>SPECIFICATIONS: INDUSTRIAL SWING &amp; SLIDE DOOR OPERATORS</b>
--

**I. GENERAL**

**A.** Furnish pneumatic operators as manufactured or supplied by Carey Automatic Door, LLC of Southbury, Connecticut. The system shall consist of: Pneumatic Operator and connecting hardware, control relay, actuating controls and accessories.

**B. Related Work Specified Elsewhere**

The general contractor shall coordinate the work of all trades, including glass and glazing, masonry, plumbing, and electrical requirements covered in manufacturer's details and appropriate sections of specifications.

**B-1. Under Electrical Section**

The electrical contractor shall provide 117v, 60 cycle, 1 phase supply to the manufacturer's control relay. Compressor motor shall be wired to nameplate voltage and phase supply.

**B-2. Under Electrical (if applicable)**

The electrical contractor shall provide electrical conduit and wiring from specified controls to control relay as outlined on manufacturer's drawings.

**B-3. Under Plumbing Section**

The plumbing contractor shall connect air compressor or central air supply to Pneumatic Operator with copper tubing and brass fittings or equivalent in accordance with lengths and sizes shown on manufacturer's details and instructions. Minimum pressure in air line before operator pressure regulator shall be at least 20 p.s.i. more than required by operator. The plumbing contractor shall check with Carey representative for air requirements, since this varies with the operator application (60 p.s.i. will be maximum operator requirements). Furnish and install drain traps where necessary for all low points or pockets in the air line.

**B-4. Under Frames and Doors (if applicable)**

Furnish and install frames and doors as specified and shown on drawings.

**B-5. Under Masonry Section (if applicable)**

The masonry contractor shall provide recess in floor for mat frames and shall set and level frames in accordance with manufacturer's drawings and instructions.

**C.** All automatic entrance equipment is to comply fully with all sections of ANSI A156.10.

**D.** All equipment must operate between -20° degrees F and +120° degrees F.

**II. PRODUCT**

**A. Operators (specify A-1, A-2 or A-3)**

**A-1. OS SINGLE ACTING PNEUMATIC OPERATORS**

**Air Power Openings and Spring Closing** - these shall be pneumatically powered from central air supply or separate compressor. Opening action shall be controlled by built-in pressure regulator and shall be adjusted for pressure and volume for required speed and power at door location. Closing speed shall be controlled by power springs and valve exhaust adjustment. Built-in adjustable two-stage checking cylinders for both opening and closing limits. Operators to contain plug-in type control relays with adjustable time delay. Operators to instantaneously recycle to full open position from any point in closing cycle.

(Continued)

<b>Carey Automatic Door, LLC</b> <b>SPECIFICATIONS: INDUSTRIAL SWING &amp; SLIDE DOOR OPERATORS</b>
--

**II. PRODUCT**

**A. Operators (specify A-1, A-2 or A-3)**

**A-2. OD DOUBLE ACTING PNEUMATIC OPERATOR**

**Air Power Openings and Air Power Closing** - these shall be pneumatically powered from central air supply or separate compressor. All Air lines to be made from non-ferrous material with air line filter. Opening and closing action shall be individually controlled by separate built-in pressure regulator sets which shall be adjustable for pressure and volume for required speed and power at door location. Operators shall be capable of operating doors against wind velocities (and equivalent stack pressures) up to 40 miles per hour. Built-in adjustable two-stage checking cylinders for both opening and closing limits. Operators to contain plug-in type electrical control relays with adjustable time delay. Operators to instantaneously recycle to full open position from any point in closing cycle.

**A-3. OSX ALL AIR OPERATOR**

**Air Openings and Air Closing (no electricity involved)** - these shall be pneumatically powered from central air supply or separate compressor. All Air lines to be made from non-ferrous material with air line filter. Opening and closing action shall be individually controlled by separate built-in pressure regulators and opening and closing valves, which shall be adjustable for pressure and volume for required speed and power. Regulators and valves shall be self-contained within a control box at door location. Operators shall be capable of operating doors against wind velocities (and equivalent stack pressures) up to 40 miles per hour. Built-in two-stage checking cylinders for both opening and closing limits. Operators to instantaneously recycle the door to full open position from any point in closing cycle. Operator shall be activated by two class 10, MA-10 pull cord valve or pneumatic palm button assemblies.

**B. Actuating Controls**

Carey shall furnish specified controls such as: palm buttons, push plates, pull cords and other accessories as manufactured by Carey Automatic Door.

**III. EXECUTION**

**A.** The general contractor shall ensure that no defects or errors are present in completed phases of the work which would result in poor application or installation, or cause latent defects of the automatic door equipment.

**Carey Automatic Door, LLC**  
**SPECIFICATIONS: SWINGING DOOR OPERATORS**

**O-1S-14" and O-1S-24" Pneumatic Swinging Door Operators**

Doors must swing freely on hinges or pivots of adequate size for good, automatic door operation. The doors, even though not supplied by Carey Pneumatic Door, must be checked for the following items as they influence the operation of your pneumatic operator equipment.

1. Check door and frame for proper installation and clearance - 1/8" at top and lead edge of door, 3/16" at the carpet or floor. Door units must be plumb, level and true to line.
2. Where door and jamb are of hollow metal construction, hinge reinforcement plates must be used.

**IF DOORS ARE HUNG ON HINGES** - Make certain that hinges are firmly secured to door and door frame. Full jeweled hinges are recommended. These are the only hinges designed to take lateral as well as vertical stress within the ball bearings, thus eliminating wear.

**IF DOORS ARE HUNG ON PIVOTS** - Check to see if pivots are secure in the header, the floor and door. If not, tighten. If they show excessive wear, make arrangements to have worn parts replaced. Door units must be plumb, level and true to line.

If doors are striking the side jambs, adjustment may be possible. Wood doors may be planed off as required to provide proper clearance. In the case of Metal or All-glass doors, if this fault prevails, the installer of the door should be called to put doors and/or frames in proper condition.

**CAREY DOOR PIVOTS** - Carey top and bottom Pivots are recommended for center pivot hung doors. See Page CPD-19.

**INSTALLATION OF HINGES:**

1. Set top hinge 5" from top of door, bottom hinge 10" from bottom of door, and center hinge midway between the two.
2. Seat hinge pin all the way in the barrel. Lock with set screw.

**Sizes of Hinges:**

**Door Thickness**

- |    |                            |        |
|----|----------------------------|--------|
| 1. | 5" x 4" hinges . . . . .   | 1-3/4" |
|    | (5" high x 4" wide - open) |        |
| 2. | 5" x 5" hinges . . . . .   | 2-1/4" |

We recommend FBB212 Hinges.

**EXTRA HEAVY BALL BEARING HINGES**

- For outside doors, use non-ferrous metal or stainless steel hinges.
- For interior doors, use steel hinges, plated or prime coated.
- Use non-template hinges on wood doors and wood frames.
- Use template hinges on wood doors with metal jambs and on hollow metal doors with pressed metal jambs.
- Use three hinges for doors up to and including 90" high.
- Use four hinges for doors up to and including 120" high.
- Use five hinges for doors over 120" high.